

01) Esquema seção A

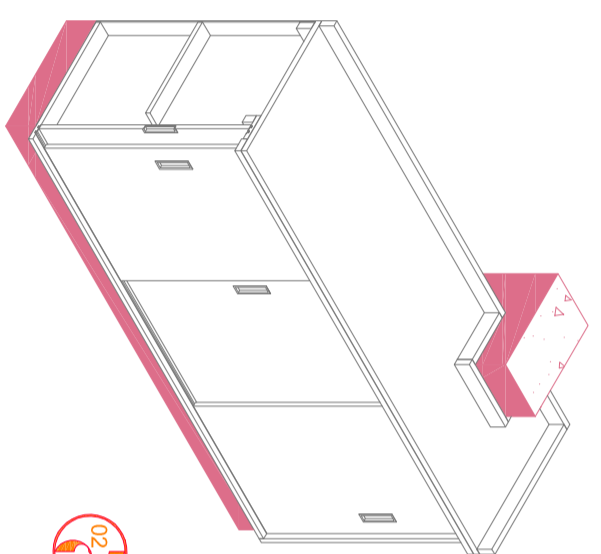

02) Esquema seção B

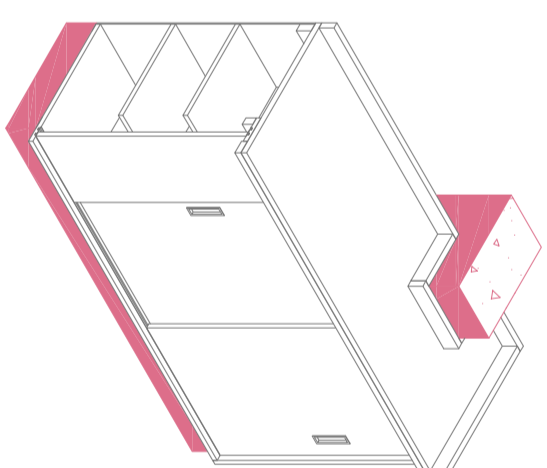

03) Esquema seção C

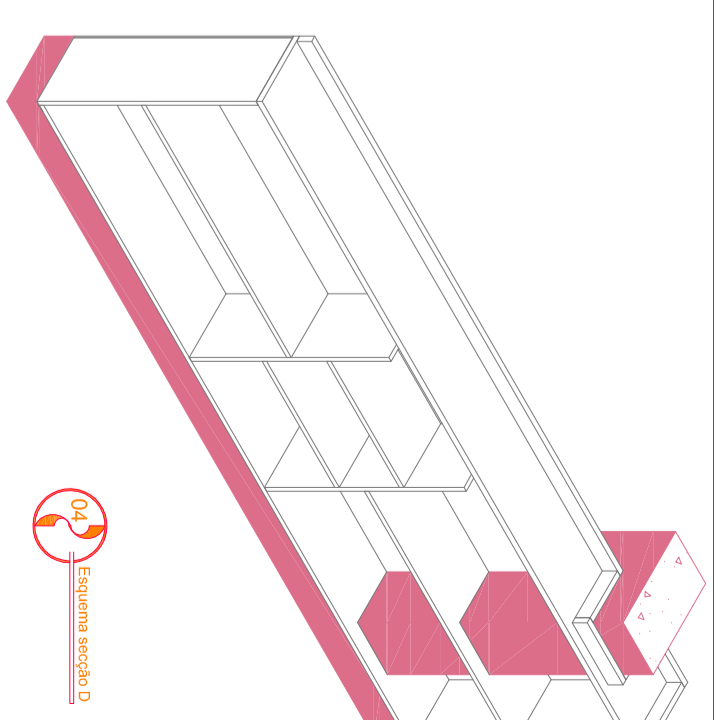

04) Esquema seção D

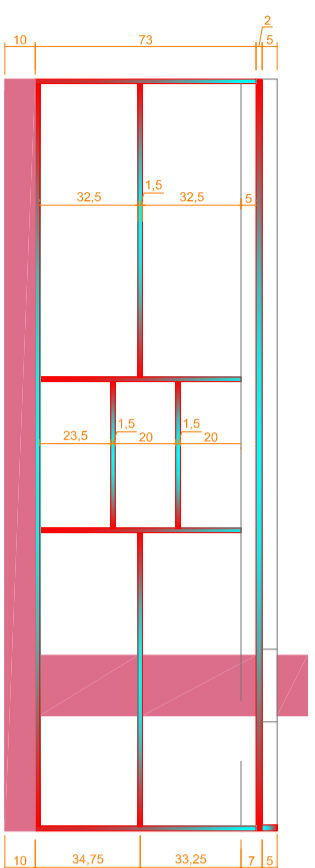

05) Seção DD  
Esc: 1/25

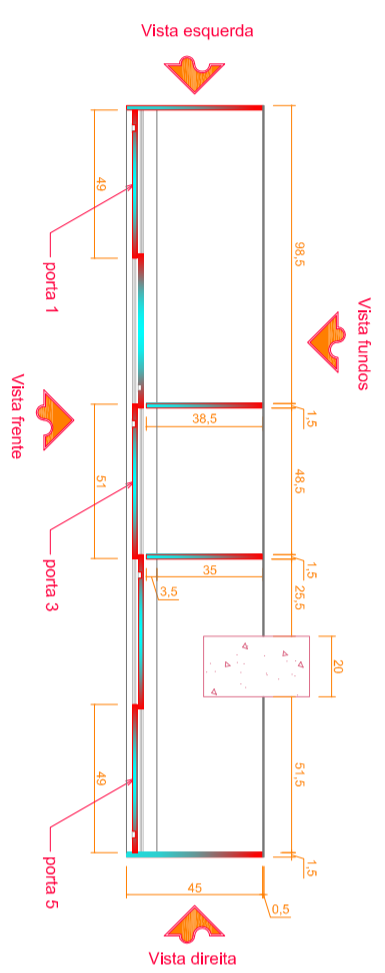

06) Seção AA1  
Esc: 1/25

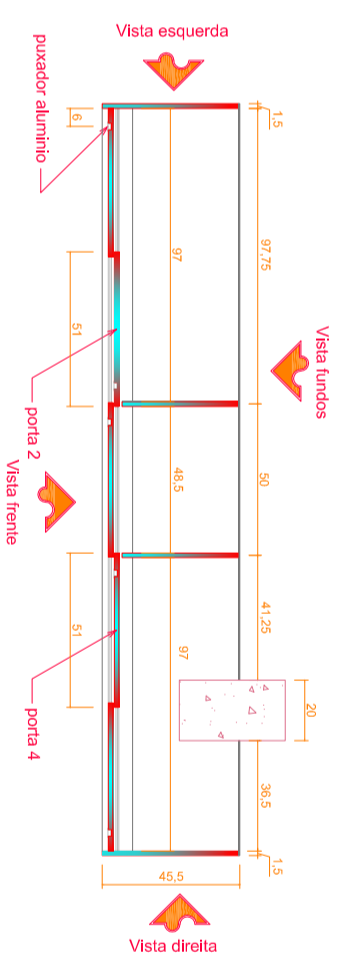

07) Seção AA2  
Esc: 1/25

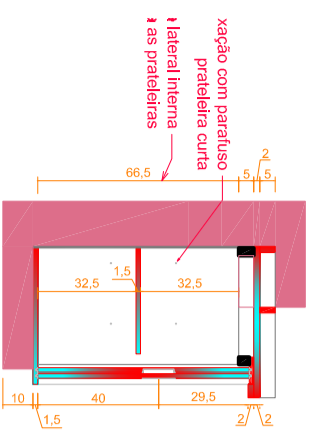

08) Seção BB  
Esc: 1/25

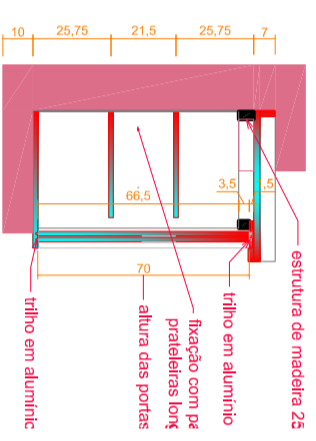

09) Seção CC1  
Esc: 1/25

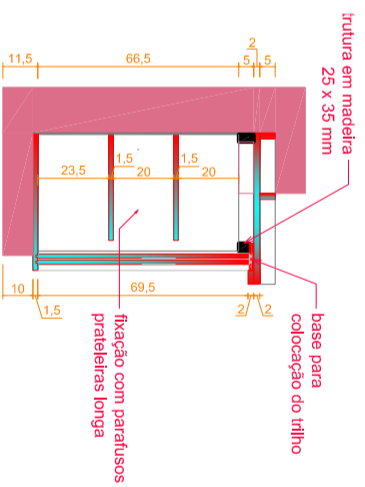

10) Seção CC2  
Esc: 1/25

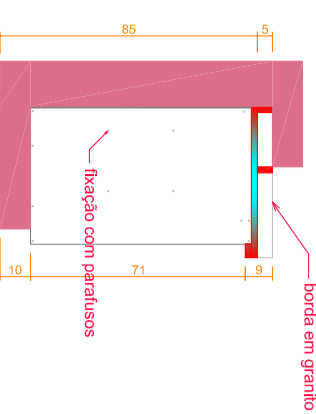

11) Vista Esquerda  
Esc: 1/25

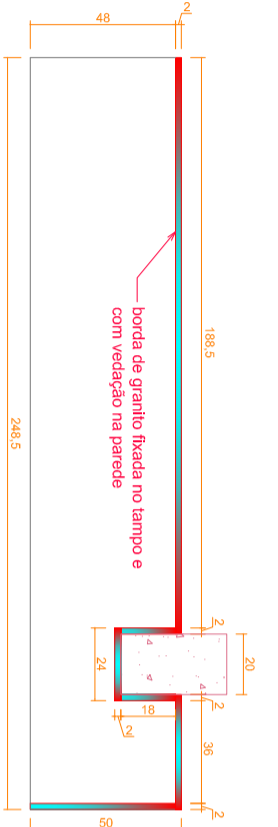

12) Vista de cima  
Esc: 1/25

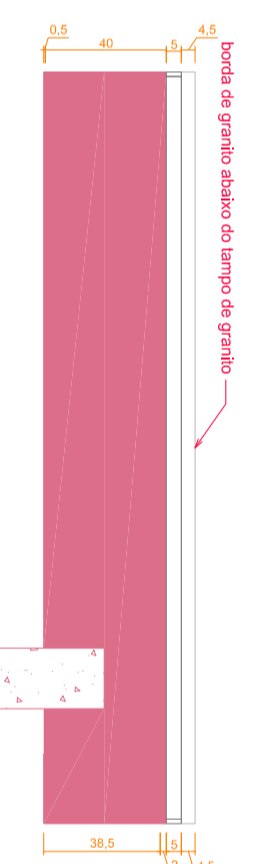

13) Vista de Baixo  
Esc: 1/25

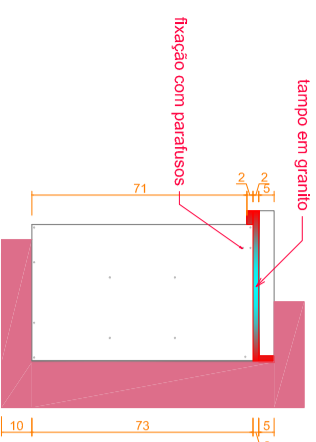

14) Vista Frente  
Esc: 1/25

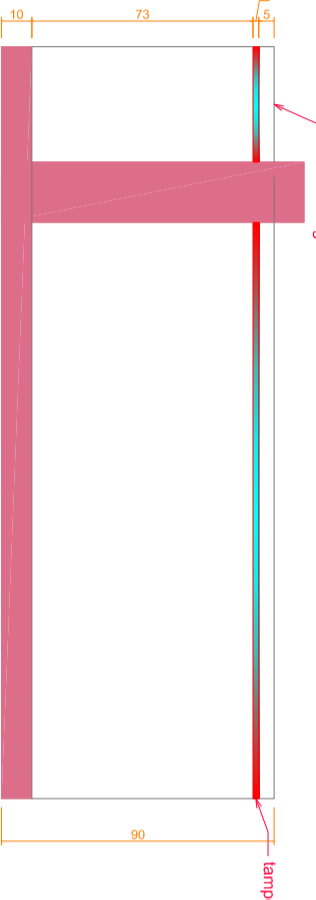

15) Vista Fundos  
Esc: 1/25

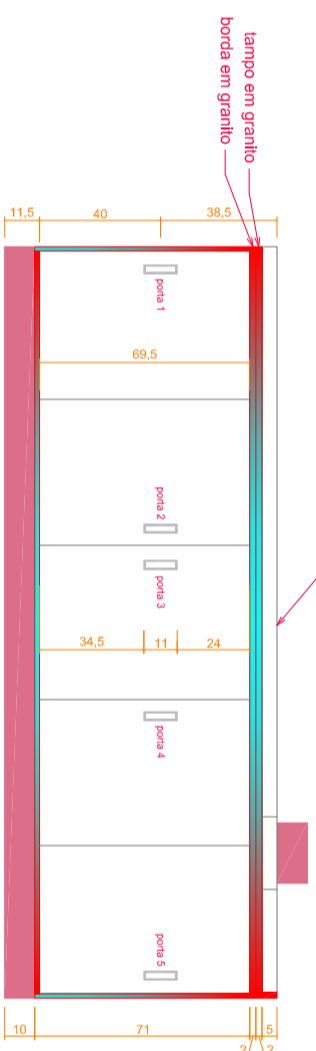

16) Vista Frente  
Esc: 1/25

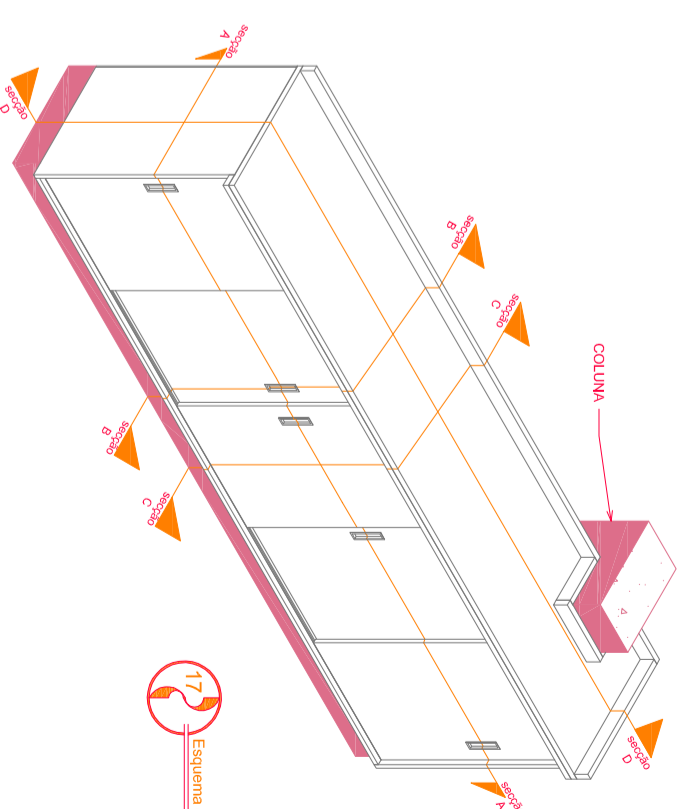

17) Esquema de seções

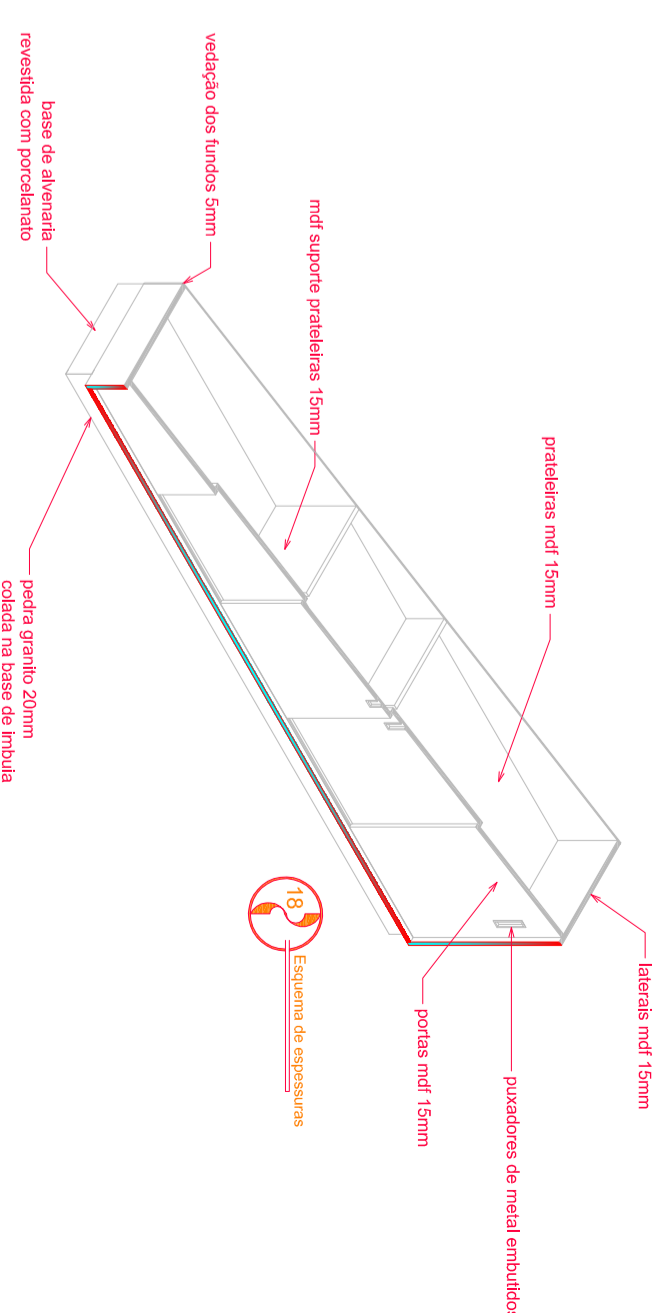

18) Esquema de seções

**PROJETO BALCÃO** 5 com interferência de coluna  
**DIMENSÕES:** comp. 248,5 x larg. 50 x alt. 85