

01 Elevação seção A

02 Elevação seção B

03 Elevação seção C

04 Elevação seção D

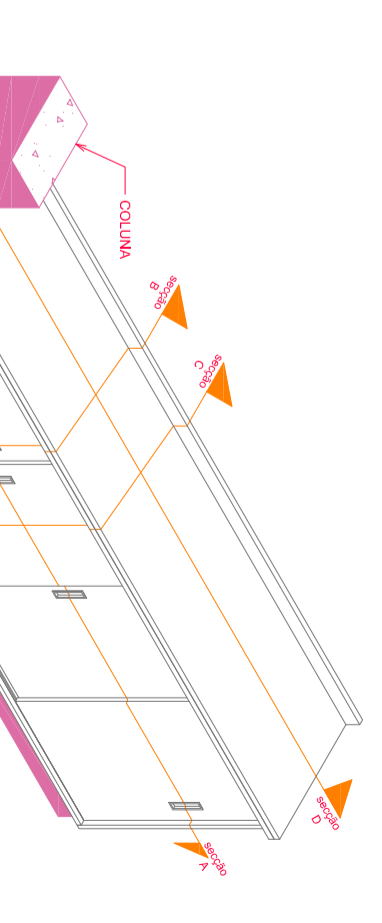
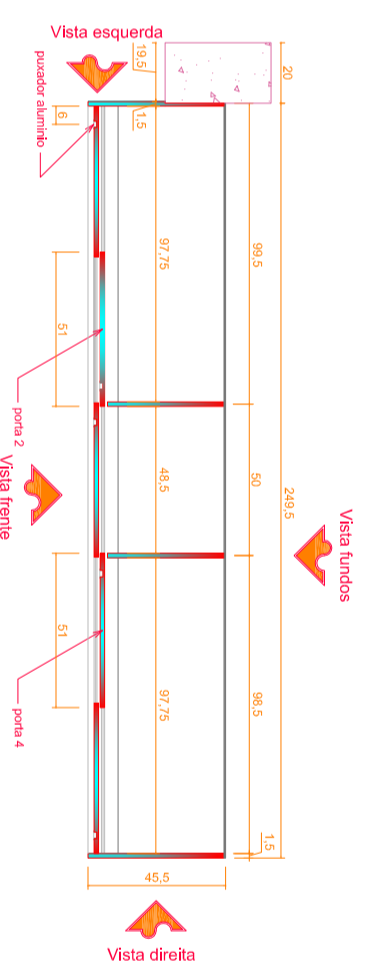
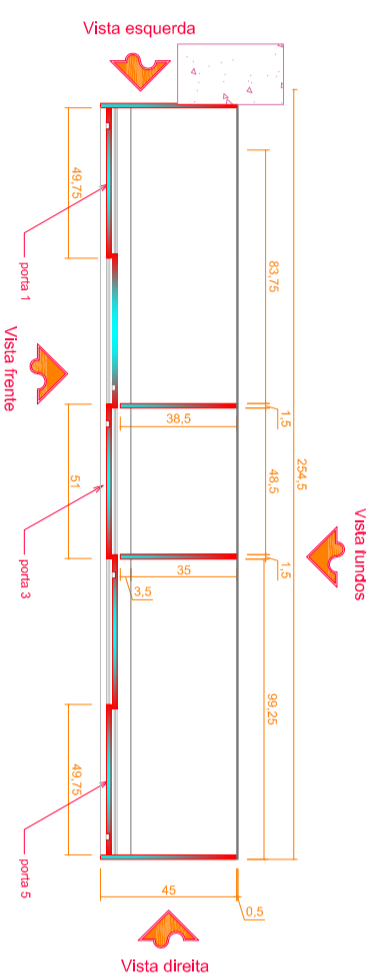
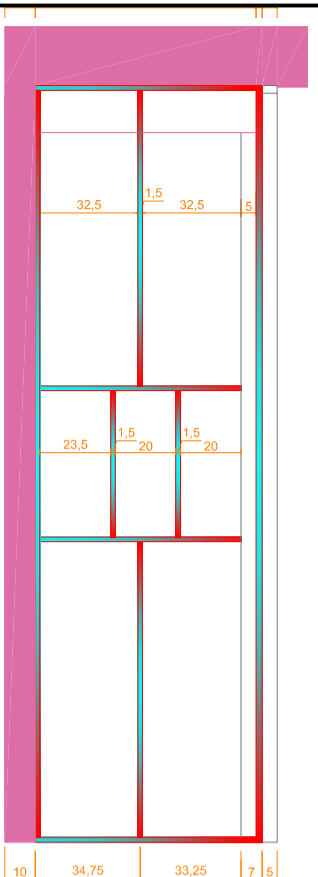

05 Seção DD
Escala: 1/25

06 Seção AA1
Escala: 1/25

07 Seção AA2
Escala: 1/25

17 Esquema de seções

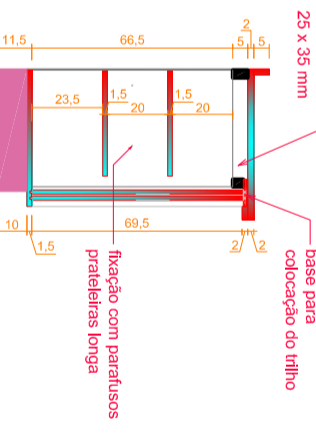
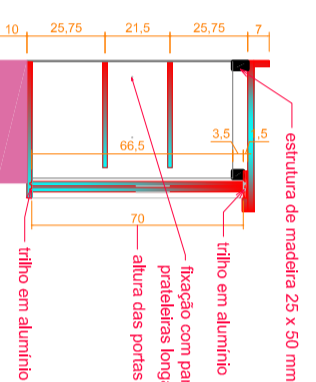
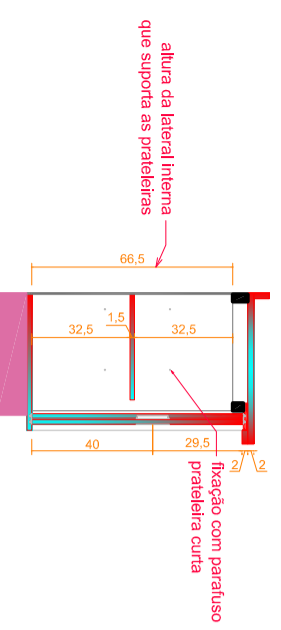

08 Seção BB
Escala: 1/25

09 Seção CC1
Escala: 1/25

10 Seção CC2
Escala: 1/25

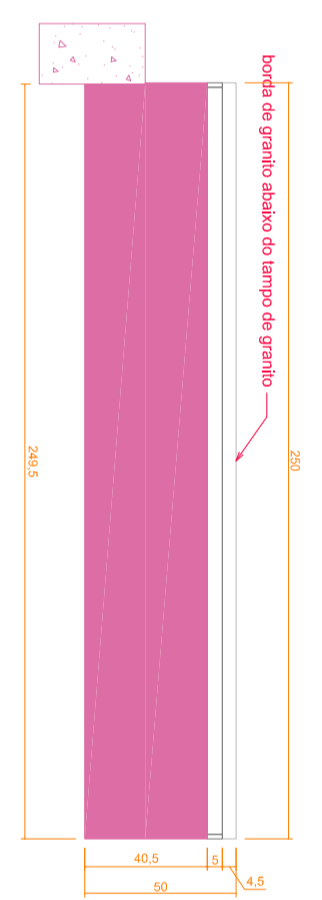
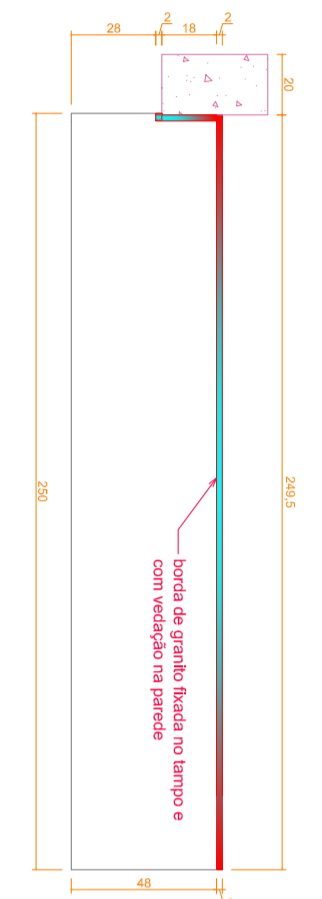
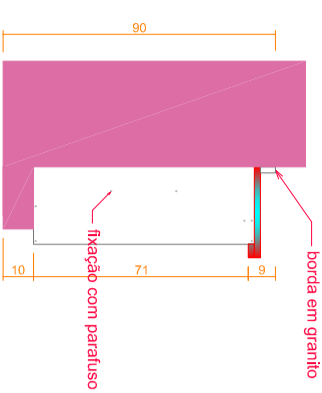

11 Vista Esquerda
Escala: 1/25

12 Vista de cima
Escala: 1/25

13 Vista de Baixo
Escala: 1/25

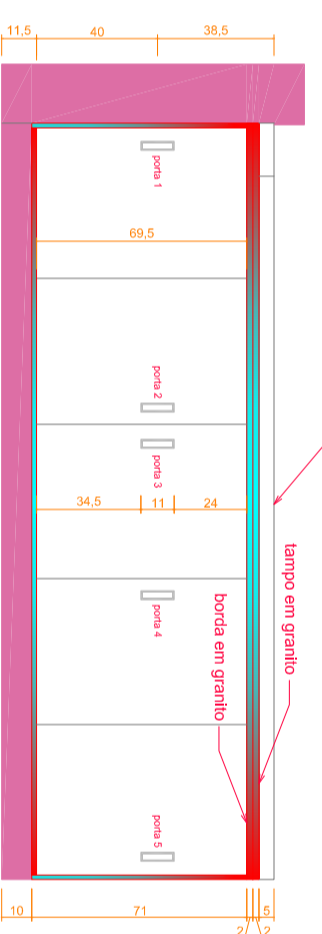
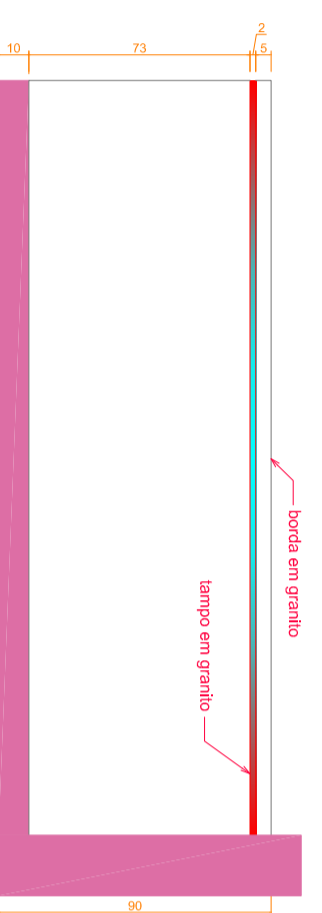
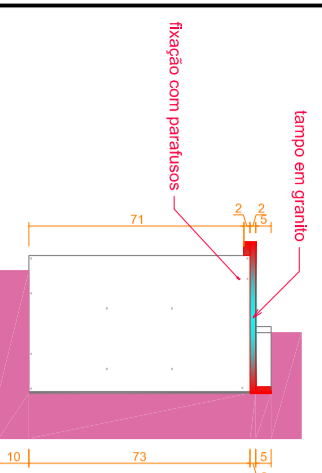

14 Vista Direita
Escala: 1/25

15 Vista Fundos
Escala: 1/25

16 Vista Frente
Escala: 1/25

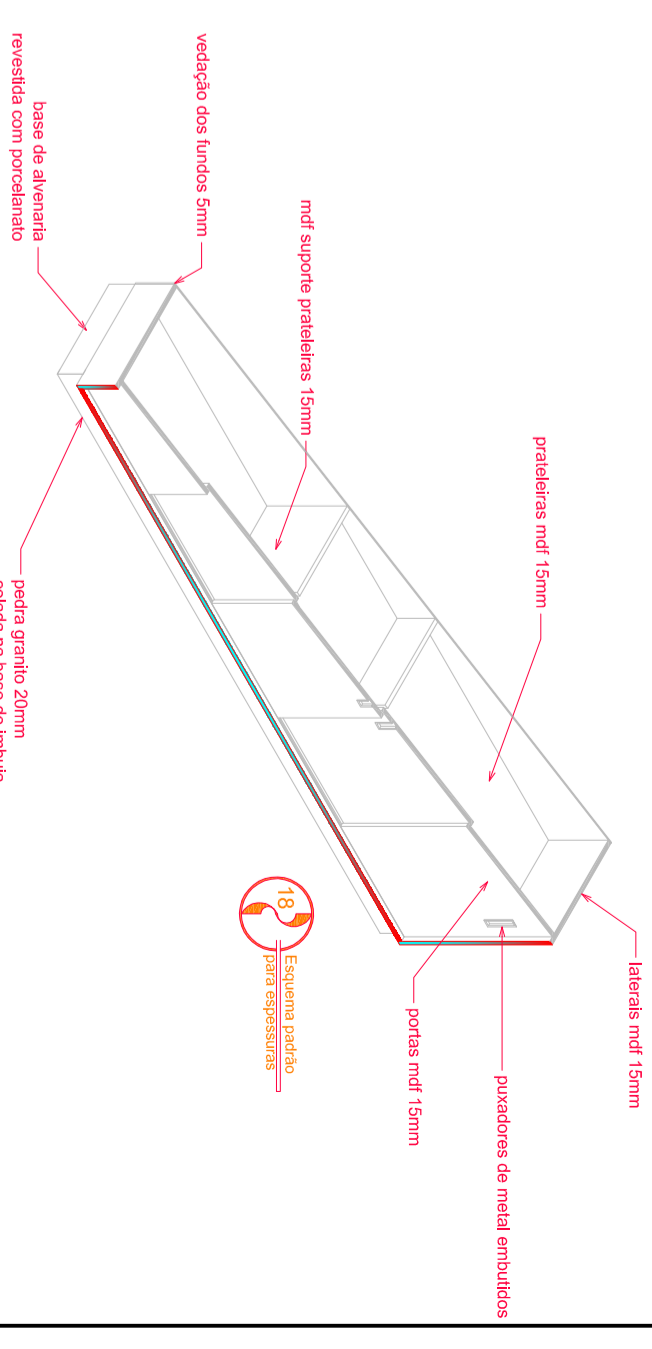

18 Esquema detalhado para o responsável

PROJETO BALCÕES 8-10 com interferência de coluna
DIMENSÕES: comp. 250 x larg. 50 x alt. 85